

# Ampco Pumps Company

Maintenance Service & Installation Manual

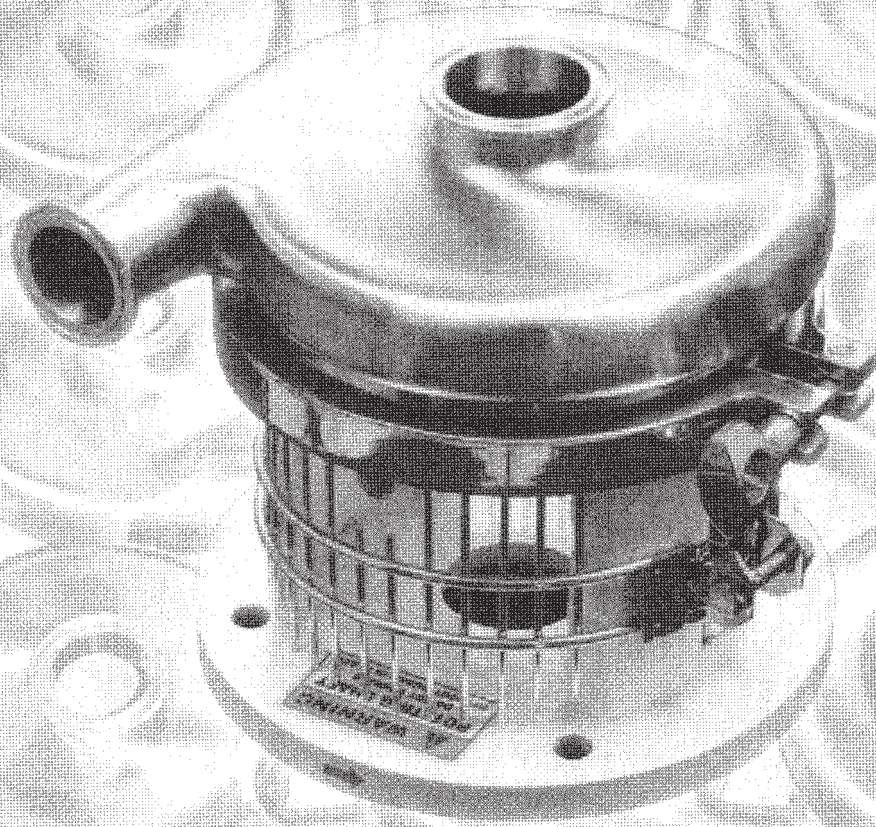

**AC Series Centrifugal Pumps**

[BACK](#)



Thank you for purchasing an Ampco AC Series centrifugal pump.

This manual contains installation, operation, cleaning and repair instructions, with parts lists, for the AC Series close-coupled pumps. It also provides a troubleshooting chart to assist in determining pump malfunction.

**READ THIS MANUAL** carefully to learn how to service and reconfigure these pumps. Failure to do so could result in personal injury or equipment damage.

**SAFETY**

Important safety information.....2

**INTRODUCTION**

Description.....3

**INSTALLATION**

Installation Guidelines.....3  
Piping hints.....4

**MAINTENANCE**

Type D or F seals external balanced.....5  
Type E water cooled balanced double seal.....9

**TROUBLESHOOTING**

Troubleshooting guidelines.....13

**GENERAL DIMENSIONS**.....14

**PARTS LIST**.....15

## IMPORTANT SAFETY INFORMATION

Safety is very important!

**DO NOT attempt to modify any AC Series pumps.** The AC Series centrifugal pumps have been designed to be safe and reliable. Modification could create unsafe conditions and will void all warranties. **DO NOT place any AC Series pumps in an application where general product service ratings are exceeded.** If the maintenance and operation personnel do not observe the instructions in this manual, personal injury or machine damage could result.

The following DANGER, WARNING, AND CAUTION signs and their meanings are used within these instructions to avoid serious injury and/or possible damage to equipment.

### DANGER

Indicates an imminently hazardous situation which, if not avoided, will result in death or serious injury. The word **DANGER** is used in the most extreme cases.

### WARNING

Indicates a potentially hazardous situation which, if not avoided, could result in minor or moderate injury. May also be used to alert against an unsafe operating or maintenance practice.

### CAUTION

Indicates a potentially hazardous situation which, if not avoided, could result in death or serious injury.

CODE  
136530001



CODE  
136530002

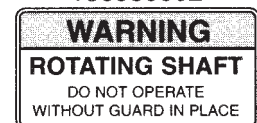

Safety labels are placed on every pump. Do not remove any labeling on any AC pumps. Replace any label that is missing.

## DESCRIPTION

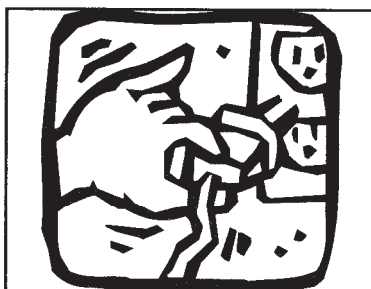

### **! WARNING**

Before servicing pump, disconnect electrical power source, carefully relieve all pressure and drain all fluids from pump and connected piping.

Before servicing pump, disconnect electrical power source.

The AC Series close-coupled pumps are made up of two sections, power or drive section and the liquid end or pump section.

The pump is mounted to the frame of the drive motor by means of an adapter, and is coupled to the motor shaft by a stainless steel stub shaft. The impeller mounts on the stub shaft and is retained by one of two methods. The casing is clamped to the adapter, greatly simplifying removal, and also permitting positioning of the discharge outlet through 360°. The external, balanced seal assures long seal life. The drive motor is mounted on a frame having adjustable legs providing simple installation and leveling.

## INSTALLATION GUIDELINES

### **UNPACKING EQUIPMENT**

Check the contents and all wrapping when unpacking your equipment. Inspect all parts for damage that may have occurred during shipping. Report any damage to the carrier.

### **LOCATION AND INSTALLATION**

The pump unit should be located as near as possible to the liquid source and in a position where the suction piping can be short and direct with a minimum number of elbows and fittings. It should also be readily accessible for inspection and cleaning.

The pump unit as received from the factory is ready for installation. To install it, attach a hoist, if necessary, loosen the setscrews in the adjusting leg brackets, and individually adjust the legs until the pump unit is level. Tighten the setscrews.

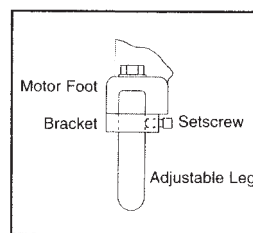

Attach the suction and discharge piping. Be sure suction and discharge piping is properly supported to avoid any strain on the pump casing.



## PIPING HINTS

### GENERAL

This section provides some do's and don'ts of piping which will aid in obtaining the maximum efficiency and service from your pump.

Piping should be independently supported at both the suction inlet and discharge outlet. Care should be taken that piping is properly aligned and does not put any strain on the pump casing. The piping should have as few bends as possible.

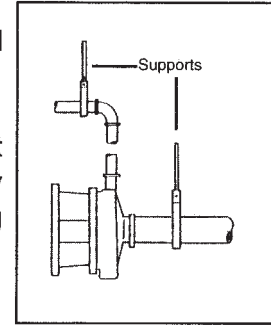

The suction piping should be short and follow a direct route with a minimum number of elbows and fittings. Elbows should be located as far as possible from the suction inlet to prevent head loss due to increased friction. Excessive friction losses in the suction line could result in pump cavitation, causing poor performance, noise, vibration, damage to equipment, and possible damage to product.

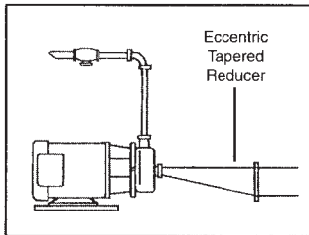

Whenever practical the diameter of the piping at the suction inlet should be increased in size. An eccentric tapered reducer should be used in lieu of a concentric tapered reducer to prevent air pockets from forming and impairing pump efficiency. In turn, the eccentric reducer may be placed at the inlet of the pump and should be positioned so the straight side is up.

A horizontal suction pipe must have a gradual rise to the pump. A high point in the suction line will form an air pocket and prevent proper pump operation. All joints in the suction line should be air tight, to prevent air leakage which can reduce pump capacity and efficiency.

### DISCHARGE PIPING

Position of the pump discharge is preferably either vertical or top horizontal. The discharge piping should be short and direct with a minimum number of elbows and fittings. Elbows should not be used at the discharge outlet, as the friction encountered would be increased, resulting in head loss. It is advisable to increase the pipe diameter at the discharge outlet to prevent head loss. However, use of a larger discharge pipe than recommended may reduce the total pump head, but increase the pump volume, which can cause pump vibration due to overload. Use of a discharge pipe smaller than the pump discharge outlet increases the total pump head but decreases the volume. If a reducer is required on the outlet port of the pump and the discharge is vertical a **concentric reducer** should be used. If the discharge is horizontal an **eccentric reducer** should be used and should be positioned so the straight side is down.

### LOCATING VALVES

In suction lift applications where the lift is not very high, it may be desirable to install a foot valve, to facilitate priming, and to prevent draining off of the liquid back to the source. A throttling valve should be installed in the discharge piping to provide control pump flow rate and prevent motor overload.

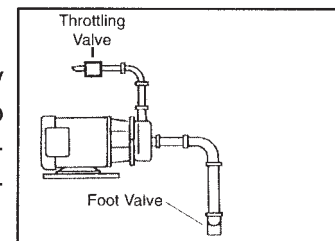

# TYPE D OR F SEALS EXTERNAL BALANCED

## DISASSEMBLY, CLEANING (GENERAL)

	⚠ WARNING
	<p>Before servicing pump, disconnect electrical power source, carefully relieve all pressure and drain all fluids from pump and connected piping.</p>

It is necessary to disassemble parts of the pump for cleaning and sanitizing. For AC Series pumps equipped with the “Groove-In-Shaft” design (types D, DG, or F seals only), it is not necessary to disassemble if used in Clean-In-Place installation.

The extent of disassembly will depend on the application, and the type of seal used in your pump. To disassemble, disconnect the suction and discharge piping. Remove seal guard assembly with a wrench of appropriate size. Turn the wing nut on the clamp assembly until tension on the clamp saddle is relieved. Open the saddles and remove the casing. At this point the disassembly varies depending on the impeller retaining system applicable to your pump.

### **For floating retainer models**

Push back on the impeller and center the retainer in the stub shaft. Slide the impeller forward and remove it. Do not try to remove retainer before removing impeller, as this will cause damage to the retainer, shaft and impeller.

### **For threaded shaft models**

Remove cotter pin and turn castellated nut in counterclockwise direction. Remove washers and impeller.

### **For both models**

1. Rotate the backplate until the backplate pins clear the pins in the adapter and remove the backplate.
2. Remove the casing gasket.

**NOTE:** Protect the sealing surface of the backplate against nicks and scratches while removing, cleaning and reassembling.

3. Remove the carbon seal, o-ring seal, seal cup, and spring.

### **DG/FG CLAMPED IN SEAT**

1. Remove four bolt/screws from backplate. Inspect DG seat insert, gland ring, and gaskets for damage or wear, and replace as required.

**NOTE:** #80P outboard and #80R inboard gaskets are NOT INTERCHANGEABLE. #80R (thicker) gasket MUST be inboard-between backplate and seal seat. Care must be taken to protect the sealing face of the backplate for D and F seals and the seal seat for DG seals from nicks and scratches.

2. Remove the carbon seal and o-ring seal. Examine and replace as necessary.

## REPAIR

It is recommended that periodic inspection of all parts of the pump be made to prevent malfunctions caused by worn or broken parts. Disassembly for repair is the same procedure as for cleaning.

**NOTE:** Protect the sealing surface of the backplate against nicks and scratches while removing, cleaning and reassembling.

1. For D and F seals, examine the backplate sealing surface carefully for any defects that will shorten seal life.
2. Remove the carbon seal, o-ring seal, cup and spring. Remove the drive collar by loosening set screws and sliding collar off the stub shaft.
3. The balanced seal is designed for outside application. Sealing of the process fluid along the shaft is accomplished by action of the process pressure on an o-ring seal installed in a groove in the carbon seal. The same action pressurizes the o-ring groove and augments the spring tension in keeping a tight joint at the sealing faces. The location or width of the sealing face controls the balancing of the seal.
4. Carefully inspect the o-ring seal and carbon seal for signs of abrasions, cuts or other wear that would cause leakage. When the extension of the carbon seal face extends less than 1/32" from the body, it is advisable that the carbon seal be replaced.
5. Remove the cascading water attachment if included. Remove the rubber shaft deflector by prying it gently from the rear, while sliding it forward. Examine the deflector for tearing, loose fit, or other defects that would allow fluid leakage into the motor along the armature shaft. If the deflector is damaged, it should be replaced.
6. Remove the bolts securing the adapter to the motor frame and remove the adapter. Loosen the 4 set screws securing the stub shaft to the motor armature. Remove the stub shaft by prying from the back with a flat bar. The stub shaft is a tight fit but can be removed by evenly applying pressure around the periphery of the shaft with the flat bar.
7. Examine the stub shaft sealing surface for nicks or scratches which can cause excessive o-ring seal wear or leaking.
8. Attach a hoist to the motor if necessary, and remove the bolts securing the motor to the adjusting leg brackets. Remove the set screws securing the adjustable legs and remove the legs.

**NOTE:** The metal displaced by the set screws on the adjustable legs makes it necessary to tap the legs out with a soft hammer. Rough spots should be filed down prior to reassembly.

9. Inspect casing clamp for damage or wear and replace as required. Inspect the adjusting legs, adjusting leg brackets, adapter and casing and replace if necessary. Motor maintenance, repair and wiring are not covered in this manual. For specific information, contact the motor manufacturer.



## REASSEMBLY

1. Assemble the adjusting legs to the adjusting leg brackets, and assemble the brackets to the motor. Level the motor by individually adjusting the legs and locking them in place with the set screws.
2. Install the adapter to the motor, with the drain cavity at the bottom. Insert the four bolts securing the adapter to the motor. Tighten the bolts securely.
3. Assemble the stub shaft to the motor armature shaft. Do not tighten set screws at this point
4. Install the backplate by rotating it until the pins in the backplate engage the pins in the adapter bracket.

### For floating retainer models

Install the backplate by rotating it until the pins in the backplate engage the pins in the adapter. Rotate the shaft until the floating pin hole is in a horizontal position. Insert the floating retainer, center it in the shaft, and slide the impeller on the shaft. Hold the impeller tight against the shoulder on the shaft and rotate the shaft one-fourth turn until the floating retainer drops and engages the impeller.

### For threaded shaft models

Slide the impeller on the shaft and replace washer and castellated nut and cotter pin.

### For both models

1. Assemble the clamp to the adapter, and install the casing.
2. Push the stub shaft onto the motor shaft until the impeller strikes the inside front face of the backplate. Locate the stub shaft on the motor shaft allowing 1/16" (1.5mm) maximum clearance between the rear face of the impeller and the inside face of the backplate. Tighten the four set screws on the stub shaft. Remove casing, impeller, impeller pin and backplate.
3. Slide the rubber deflector on the shaft until it seats the groove in the shaft.
4. Slide drive collar onto stub shaft, and locate per setting instructions in next section. Assemble the spring, seal cup, o-ring seal and carbon seal, and install as a unit, taking care that slot in seal cup should be aligned with pin in drive collar. Gentle finger pressure will overcome o-ring resistance on the shaft.

**NOTE:** Do not lubricate seal with any type of oil or grease. The seal faces are lubricated by product being pumped.

### For floating retainer models

Rotate the shaft until the floating pin hole is in a horizontal position. Insert the floating retainer, center it in the shaft, and slide the impeller on the shaft. Hold the impeller tight against the shoulder on the shaft and rotate the shaft one-fourth turn until the floating retainer drops and engages the impeller.



**For threaded shaft models**

Install the backplate by rotating it until the pins in the backplate engage the pins in the adapter. Slide the impeller on the shaft. Install washers and thread the castellated nut to the shaft in a clockwise direction until impeller hub contacts shaft shoulder. Use a combination of washers if needed to ensure that the castellated nut is tight on the impeller before inserting and securing cotter pin.

**For both models**

1. Install gasket on backplate.
2. Place the casing in position and close and tighten the clamp while lightly tapping the clamp with a hammer to ensure even tightening. Assemble seal guard and tighten nut.
3. Assemble the cascading water attachment, if so equipped, to the adapter. Close and tighten the clamp. Assemble the suction and discharge piping to the pump. Check for strain on the casing. Adjust as necessary.

**EXTERNAL BALANCED SEALS - SETTING SEAL DRIVE COLLAR LOCATION**

The balanced seal is designed for outside applications, and is available with cascading water attachment. Sealing of the process fluid along the shaft is accomplished by action of the process pressure on an o-ring seal installed in a groove in the carbon seal. The same action pressurizes the o-ring groove and augments the spring tension in keeping a tight joint at the sealing faces. The width of the seal face controls balancing of the seal. This type of seal should be replaced when the clearance between the carbon seal face and the backplate is less than 1/32" (0.79mm), or when leakage is noted.

To replace the seal:

1. Disconnect the suction and discharge piping, and remove the casing, impeller and backplate as described.
2. Assemble the spring, seal cup, o-ring seal and carbon seal, and install as a unit, taking care that slot in seal cup is aligned with pin on drive collar. Gentle finger pressure will overcome o-ring resistance on the shaft.

When the carbon seal is replaced, the location of the drive collar should be checked and relocated if necessary by one of the two following methods.

**Setting the Drive Collar by Measurement**

1. Install the backplate, gasket and casing.
2. Install and tighten casing clamp.
3. At a location behind the backplate scribe a mark on the shaft. See next two figures.
4. Remove casing clamp, casing, & backplate.
5. Slide the drive collar onto the shaft.
6. Locate drive collar in relation to the scribe mark as shown in dimension A and secure to the shaft with the set screws. Drive collar location is critical.
7. Install the seal spring, seal cups, seal o-ring and carbon onto the shaft.

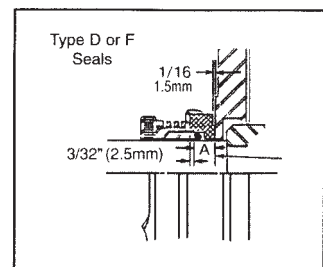

**SETTING THE DRIVE COLLAR BY POSITION**

1. Assemble the spring, seal cup, o-ring seal, and carbon seal onto the drive collar. Care must be taken so that the spring does not rest on the tab that is bent back. A portion of the spring is offset to provide clearance for this tab. Care must be taken to ensure that pin on drive collar is in line with slot on cup.

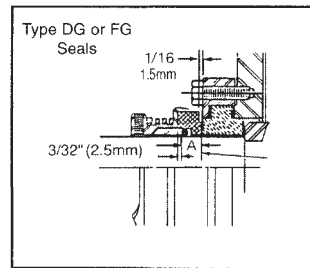

2. Install as a unit on the shaft.
3. Install the backplate and casing.
4. Install and tighten the casing clamp.
5. Slide the drive collar and seal assembly toward the backplate until the nose of the drive collar pushes the o-ring and carbon seal tight against the backplate.
6. Slide the drive collar away from the backplate 1/32" (0.79mm) and secure the drive collar in this location with the set screws.

**NOTE:** Extra care should be taken when assembling AC Series pumps with type DG or FG seals. Incorrect stub shaft settings will allow the impeller hub to contact the inboard face of the stationary seal seat. Interference of the impeller hub and seal seat face will cause wear of impeller hub and damage the inboard or secondary seal face of the clamped-in seat. Visual inspection is recommended after installation of the impeller, and before installation of casing to ensure clearance between the impeller hub and seal face. If no clearance is visible, the pump should be disassembled and stub shaft moved forward to provide at least 1/32" (.79mm) clearance between the impeller hub and seal seat face. Reset seal drive collar if necessary.

7. When the drive collar is properly positioned and seal components are properly installed, the pump shaft should rotate freely by hand. If excessive effort is required to rotate the shaft, check to be sure that all components are properly installed and the drive collar is properly positioned.

**TYPE E WATER COOLED BALANCED DOUBLE SEAL**  
**DISASSEMBLY, CLEANING (GENERAL)**

	<b>⚠ WARNING</b>
	<p>Before servicing pump, disconnect electrical power source, carefully relieve all pressure and drain all fluids from pump and connected piping.</p>

It is necessary to disassemble parts of the pump for cleaning and sanitizing.



The extent of disassembly will depend on the application, and the type of seal used in your pump. To disassemble, disconnect the suction and discharge piping. Remove seal guard assembly with wrench of appropriate size. Turn the wing nut on the clamp assembly until tension on the clamp saddle is relieved. Open the saddles and remove the casing. At this point the disassembly varies depending on the impeller retaining system applicable to your pump.

### For floating retainer models

Pushback on the impeller and center the retainer in the stub shaft. Slide the impeller forward and remove it.

### For threaded shaft models

Remove cotter pin and turn castellated nut in counterclockwise direction, and remove washer and impeller.

### For both models

Disconnect the water inlet and outlet from the stuffing box. Remove the screws that retain the follower to the stuffing box. Slide the stuffing box and backplate assembly forward off of the stub shaft. Remove the inboard carbon seal, seal o-ring, cup and seal from the shaft. Loosen the two set screws and remove the drive collar. The remaining carbon seal, seal o-ring, cup and the follower may now be removed from the shaft.

### REPAIR

It is recommended that periodic inspection of all parts of the pump be made to prevent malfunctions caused by worn or broken parts. Disassembly for repair is the same procedure as for cleaning. This seal design is used in applications where a vacuum tight, cool operating seal is required. The seal consists of two carbon seals inside a stuffing box, which is attached to the backplate. The sealing action is the same as the external balanced seal.

1. WATER MUST BE PIPED THROUGH THE STUFFING BOX TO KEEP THE SEAL COOL AND VACUUM TIGHT. The amount of water used will vary depending on the operating temperature of the pump. In vacuum applications 10 drops per minute discharge is recommended, while approximately 3 gallons per hour is required to maintain seal temperature at 100°F (79°C).
2. Two 1/8" NPT water connections are provided on the stuffing box. They are spaced at 90° from each other, and should be located when assembling the pump so that they are at 45° to vertical. Flush water must enter one of these connections and exit through the other connection.
3. Carefully inspect the o-ring seals and the carbon seals for signs of abrasions, cuts or other wear that would cause leakage. When the extension of the carbon seal face extends less than 1/32" from the body, it is advisable that the carbon seal be replaced. Inspect backplate seal surface and follower seal surface for nicks or scratches. Replace if necessary.
4. Remove the rubber shaft deflector by prying it gently from the rear, while sliding it forward. Examine the deflector for tearing, loose fit, or other defects that would allow fluid leakage into the motor along the armature shaft.

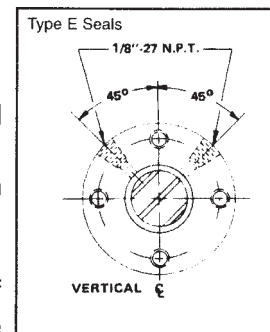

5. Remove the bolts securing the adapter to the motor frame and remove the adapter. Loosen the 4 set screws securing the stub shaft by prying from the back with a flat bar. The stub shaft is a tight fit but can be removed by evenly applying pressure around the periphery of the shaft with the pry bar.
6. Examine the stub shaft sealing surfaces for nicks or scratches, which can cause excessive o-ring seal wear, or leaking.
7. Attach a hoist to the motor if necessary, and remove the bolts securing the motor to the adjusting leg brackets. Remove the set screws securing the adjustable legs and remove the legs.

**NOTE:** The metal displaced by the setscrews on the adjustable legs makes it necessary to tap the legs out with soft hammer. Rough spots should be filed down prior to reassembly.

8. Inspect casing clamp for damage or wear, and replace as required. Inspect the adjusting legs, adjusting leg brackets, adapter and casing and replace if necessary.
9. Contact the motor manufacturer for motor maintenance recommendations.

**REASSEMBLY**

1. Assemble the adjusting legs to the adjusting leg brackets, and assemble the brackets to the motor. Level the motor by individually adjusting the legs and locking them in place with set screws.
2. Install the adapter to the motor, with the drain cavity at the bottom. Insert the four bolts securing the adapter to the motor. Tighten the bolts securely.
3. Assemble the stub shaft to the motor armature shaft. Do not tighten set screws.
4. Install the backplate into the counter-bore in the adapter.

**For floating retainer models**

Rotate the shaft until the floating pin hole is in a horizontal position. Insert the floating retainer, center it in the shaft, and slide the impeller on the shaft. Hold the impeller tight against the shoulder on the shaft and rotate the shaft one-fourth turn until the floating retainer drops and engages the impeller.

**For threaded shaft models**

Slide the impeller on the shaft and replace washer and castellated nut and cotter pin. Use a combination of washers if needed to ensure that the castellated nut is tight on the impeller before inserting and securing cotter pin.



## For both models

1. Assemble the clamp to the adapter, and install the casing.
2. Push the stub shaft onto the motor shaft until the impeller strikes the inside front face of the backplate. Locate the stub shaft on the motor shaft allowing 1/16" (1.5mm) maximum clearance between the rear face of the impeller and the inside face of the backplate. Tighten the four set screws on the stub shaft. At a location behind the backplate, scribe a mark on the shaft. This will be required to set the drive collar location as described in this section.
3. Remove casing, impeller and backplate.
4. Slide the rubber deflector on the shaft until it seats the groove in the shaft.

**NOTE:** If the deflector cannot be forced on with the fingers, a blunt instrument can be used to provide additional force at the I.D. of the deflector.

5. Slide the follower, one carbon seal, one seal o-ring, one seal cup, and drive collar onto the shaft.
6. Locate drive collar in relation to scribe mark as shown in the next figure and secure to the shaft with the set screws. Drive collar location is critical, the dimension A in all models is 11/32" (2.3 mm).
7. Install the seal spring, seal cup, seal o-ring and carbon onto the shaft. Be sure the spring is seated in each cup and the drive ear on each seal cup is not in alignment with the drive pins on the drive collar.
8. Slide the stuffing box and backplate assembly over the shaft and seal parts.
9. Secure the follower to the stuffing box using four screws.
10. Assemble the backplate, the impeller, and the casing to the pump and tighten clamp, tapping with soft hammer. (Make sure the orientation of the water connection on the stuffing box is correct).
11. Assemble seal guard and tighten nut.
12. Connect the water inlet and outlet piping to the stuffing box.
13. Assemble the suction and discharge piping to the pump.
14. Check for strain on the casing. Adjust as required.

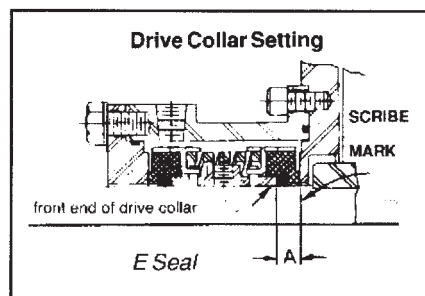

# TROUBLESHOOTING GUIDELINES

**AC Series Pumps** are relatively maintenance-free with the exception of sanitizing. Like any piece of machinery, however, occasional problems can arise. This section provides a means of determining and correcting most of your pump problems. The motor manufacturer should be contacted for specific repair instructions on the motor.

The chart below has been prepared on the basis that the pump is properly suited to its application. Should problems arise where the remedies listed below chart do not cure the situation, pump cavitation may be the problem. Symptoms of pump cavitation, such as noisy operation, insufficient discharge and vibration, can result when a pump is not properly applied. If these conditions are present, check the system and re-evaluate the application.

PROBLEM	PROBABLE CAUSE	REMEDY
1. No discharge.	<ul style="list-style-type: none"> <li>a) Pump speed too low</li> <li>b) Wrong direction of rotation.</li> <li>c) Closed valve; obstruction in discharge piping.</li> </ul>	<ul style="list-style-type: none"> <li>a) Correct wrong or poor electrical connections.</li> <li>b) Reverse a three-phase motor by switching any two of the three power leads at the motor controller; reverse a single phase motor per motor manufacturer's instructions.</li> <li>c) Open gate valve; clear obstruction.</li> </ul>
2. Insufficient discharge	<ul style="list-style-type: none"> <li>a) Pump speed too low.</li> <li>b) Wrong direction of rotation.</li> <li>c) Valve partially closed; obstruction in discharge piping.</li> <li>d) Impeller damage.</li> </ul>	<ul style="list-style-type: none"> <li>a) See 1a) above.</li> <li>b) See 1b) above.</li> <li>c) See 1c) above.</li> <li>d) Replace impeller.</li> </ul>
3. Excessive power consumption.	<ul style="list-style-type: none"> <li>a) Motor speed too high.</li> <li>b) Impeller is binding.</li> <li>c) Motor shaft is bent or worn.</li> </ul>	<ul style="list-style-type: none"> <li>a) Internal motor wiring is incorrect; replace motor.</li> <li>b) Relieve strain on casing replace defective impeller.</li> <li>c) Replace shaft.</li> </ul>
4. Pump is noisy	<ul style="list-style-type: none"> <li>a) Magnetic hum in motor.</li> <li>b) Motor bearings are worn.</li> <li>c) Foreign matter is rotating with impeller.</li> <li>d) Impeller is binding.</li> <li>e) Cavitation.</li> </ul>	<ul style="list-style-type: none"> <li>a) Consult motor manufacturer.</li> <li>b) Replace bearings.</li> <li>c) Remove casing and remove foreign matter.</li> <li>d) See 3b) above.</li> <li>e) Proper sizing or piping, etc.</li> </ul>
5. Excessive vibration.	<ul style="list-style-type: none"> <li>a) Pump is not leveled properly.</li> <li>b) Impeller is damaged.</li> <li>c) Piping is not supported.</li> <li>d) Cavitation.</li> </ul>	<ul style="list-style-type: none"> <li>a) Level pump.</li> <li>b) Replace impeller.</li> <li>c) Support discharge and suction piping.</li> <li>d) Proper sizing or piping, etc.</li> </ul>
6. Pump leaks.	<ul style="list-style-type: none"> <li>a) O-ring seal is worn or defective.</li> <li>b) Carbon seal is worn.</li> <li>c) Insufficient compression on seal assembly.</li> <li>d) Damaged inlet or outlet</li> <li>e) Backplate gasket is worn</li> <li>f) Clamp is loose.</li> </ul>	<ul style="list-style-type: none"> <li>a) Replace o-ring seal.</li> <li>b) Replace carbon seal.</li> <li>c) Replace spring.</li> <li>d) Replace casing.</li> <li>e) Replace gasket.</li> <li>f) Tighten clamp.</li> </ul>



PUMP DIMENSIONS WITH MOTOR

MODEL	FRAME	HP	A	B	C	C*	D	D*	HD	AB	Hp
AC-100	56C	1/4 - 1 1/2	6 1/2"	9 7/32"	17 5/8"		13 1/4"		5 1/2"	3 1/4"	1/4 - 1 1/2
	143TC	1/2 - 1 1/2	9 11/16"	9 1/2"	19 31/32"		15 13/16"		6"	6 15/16"	1/2 - 1 1/2
AC-114	56C	1/4 - 1 1/2	6 1/2"	9 7/32"	16 11/16"	16 15/16"	12 9/16"	12 13/16"	5 1/2"	3 1/4"	1/4 - 1 1/2
	143TC	1/2 - 1 1/2	9 11/16"	9 1/2"	19 1/4"	19 1/2"	15 1/8"	15 3/8"	6"	6 15/16"	1/2 - 1 1/2
	145TC	1 1/2 - 2	9 11/16"	9 1/2"	19 1/4"	19 1/2"	15 1/8"	15 3/8"	6"	6 15/16"	1 1/2 - 2
	182TC	3	11 5/8"	11 7/16"	22 1/4"	22 1/2"	14 15/16"	15 1/16"	6 31/32"	7 7/8"	3
AC-216	143TC	1/2 - 1 1/2	9 11/16"	9 1/2"	19 1/4"	19 1/2"	15 1/8"	15 3/8"	6"	6 15/16"	1/2 - 1 1/2
	145TC	1 1/2 - 2	9 11/16"	9 1/2"	19 1/4"	19 1/2"	15 1/8"	15 3/8"	6"	6 15/16"	1 1/2 - 2
	182TC	3	11 5/8"	11 7/16"	22 1/4"	22 1/2"	14 15/16"	15 3/16"	6 31/32"	7 7/8"	3
	184TC	5	11 5/8"	11 7/16"	22 1/4"	22 1/2"	14 15/16"	15 3/16"	6 31/32"	7 7/8"	5
	213TC	7 1/2	13 1/8"	12 15/16"	25 13/16"	26 1/16"	16 15/16"	17 3/16"	7 23/32"	8 7/8"	7.5
	215TC	10	13 1/8"	12 15/16"	25 13/16"	26 1/16"	16 15/16"	17 3/16"	7 23/32"	8 7/8"	10
	254TC	15	14 1/2"	15 1/32"	31 1/16"	31 5/16"	19 13/16"	20 1/16"	8 3/4"	9 1/2"	15
256TC	20	14 1/2"	15 1/32"	31 1/16"	31 5/16"	19 13/16"	20 1/16"	8 3/4"	9 1/2"	20	
AC-218	145TC	1 1/2 - 2	9 11/16"	9 1/2"	19 1/4"	19 1/2"	15 1/8"	15 3/8"	6"	6 15/16"	1 1/2 - 2
	182TC	3	11 5/8"	11 7/16"	22 1/4"	22 1/2"	14 15/16"	15 3/16"	6 31/32"	7 7/8"	3
AC-218	184TC	5	11 5/8"	11 7/16"	22 1/4"	22 1/2"	14 15/16"	15 3/16"	6 31/32"	7 7/8"	5
AC-328	213TC	7 1/2	13 1/8"	12 15/16"	25 13/16"	26 1/16"	16 15/16"	17 3/16"	7 23/32"	8 7/8"	7.5
	215TC	10	13 1/8"	12 15/16"	25 13/16"	26 1/16"	16 15/16"	17 3/16"	7 23/32"	8 7/8"	10
	254TC	15	14 1/2"	15 1/32"	31 1/16"	31 5/16"	19 13/16"	20 1/16"	8 3/4"	9 1/2"	15
	256TC	20	14 1/2"	15 1/32"	31 1/16"	31 5/16"	19 13/16"	20 1/16"	8 3/4"	9 1/2"	20

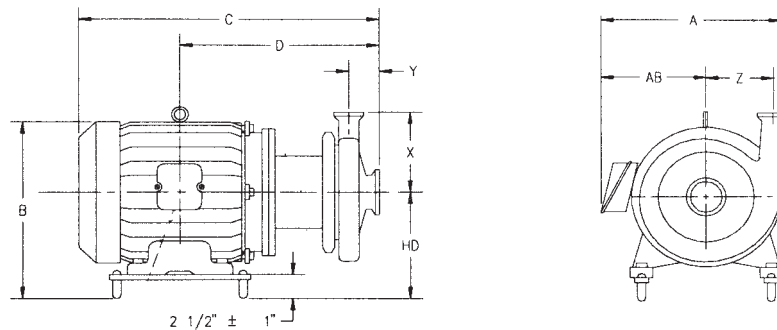

PUMP DIMENSIONS

Model	Inlet	Outlet	X	X*	Y	Y*	Z
AC-100	1 1/2"	1"	3 1/2"	3 11/16"	2.335"	1.773	1 29/64"
AC-114	1 1/2"	1 1/2"	3 5/8"	3 7/8"	1 5/8"	1 7/8"	2 5/8"
AC-216	2"	1 1/2"	4 1/2"	4 3/4"	1 15/16"	2 3/16"	3 11/16"
AC-218	2"	1 1/2"	5 1/2"	5 3/4"	1 15/16"	2 3/16"	4 3/4"
AC-328	3"	2"	5 1/2"	5 3/4"	2 1/4"	2 3/4"	4 3/4"

# AC Series Pumps

Key	Description	Qty
1	Casing	1
2	Impeller	1
6A	Set Screw (Shaft)	4
6E	Universal stub Shaft-STD	1
11	Backplate	1
11B	Backplate	1
11F	Backplate Pin	2
11H	Backplate (DG)	1
17	Follower	1
17A	Machine Screw	4
17B	O-ring	1
17C	Lockwasher	4
17J	SS Gland Ring (DG)	1
17K	Bolt/Screw (DG)	4
17M	Lockwasher (DG)	4**
24	Retainer (Impeller)	1
40	Deflector	1
71	Adapter	1
71A	Adapter Pin	2
71B	Adapter Mounting Screw	4
75	Clamp Assembly Complete	1
80	Carbon Seal	1 or 2*
80A	Cup	1
80B	O-ring (Seal)	1 or 2*
80C	Spring	1
80G	Cup	2
80H	Spring	1
80J	Drive Collar	1
80K	Set Screw	2
80L	Drive Collar	1
80M	Set Screw-Drive collar	2
80N	Seal Seat (DG)	1
80P	PTFE Gaskets (DG)	1 or 2**
80R	PTFE Gaskets (DG)	1**
83C	Stuffing Box	1
83D	Machine Screw	4
83E	O-ring	1
90	Casing Gasket	1
127	Water Inlet Assembly	1
131	Seal Guard Assembly	1
207	Adjustable Leg	4
209	Adjustable Leg Bracket	2
209A	Set Screw (Square head.)	4
209B	Bracket Mounting Screw	4
209C	Washer (Leg Assembly)	4

\* E seal takes 2.

\*\* Gaskets are not interchangeable

**PARTS LIST**



# Ampco Pumps Company — AC Series Centrifugal Pumps

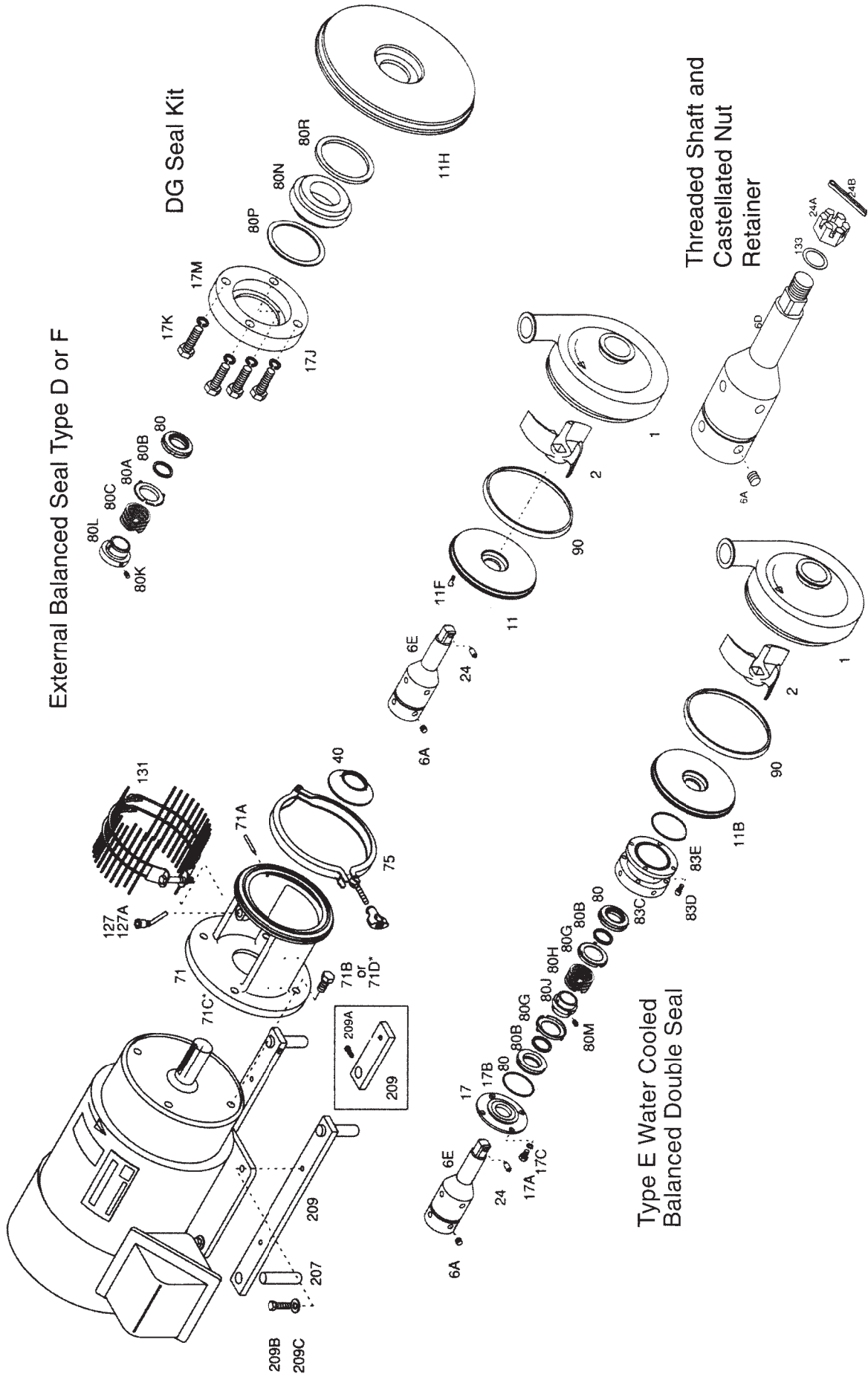

## AC SERIES WARRANTY AND TERMS

Each **AC Series pump** is warranted to be free from manufacturing defects for a period of one (1) year from the date of shipment, if it has been used as recommended and in accordance with recognized piping practice, and this warranty will not apply to products which require repair or replacement due to normal wear and tear or to products which are subjected to accident, or improper maintenance.

This warranty is expressly in lieu of any other warranties, express or implied, including without limitation any warranty of merchantability of fitness for a particular purpose. In no event shall **Ampco Pumps** be liable for any special consequential incidental or indirect damages including loss of profits.

The cost of removing and/or installing products which have been repaired or replaced shall be at buyer's expense. Purchaser's sole and exclusive remedy and **Ampco Pumps'** maximum liability for claims arising hereunder or for negligence for any and all losses and damages resulting from any cause shall be either the repair or replacement of defective products.

## **Ampco Pumps Company**

4424 W. Mitchell Street  
Milwaukee, WI 53214  
Phone (414) 643-1852  
Fax (414) 643-4452  
[www.ampcopumps.com](http://www.ampcopumps.com)